

SECTION OF MOLDING & TRAIL BOARD
AT & SHIP
SCALE: FULL SIZE

NOTE THE THICKNESS OF MOLDING & BOARD REMAIN CONSTANT VIZ: 2" & 1 1/8". THE WIDTH HOWEVER, CHANGES CONSTANTLY, TAPERING TO TOTAL WIDTH OF 9".

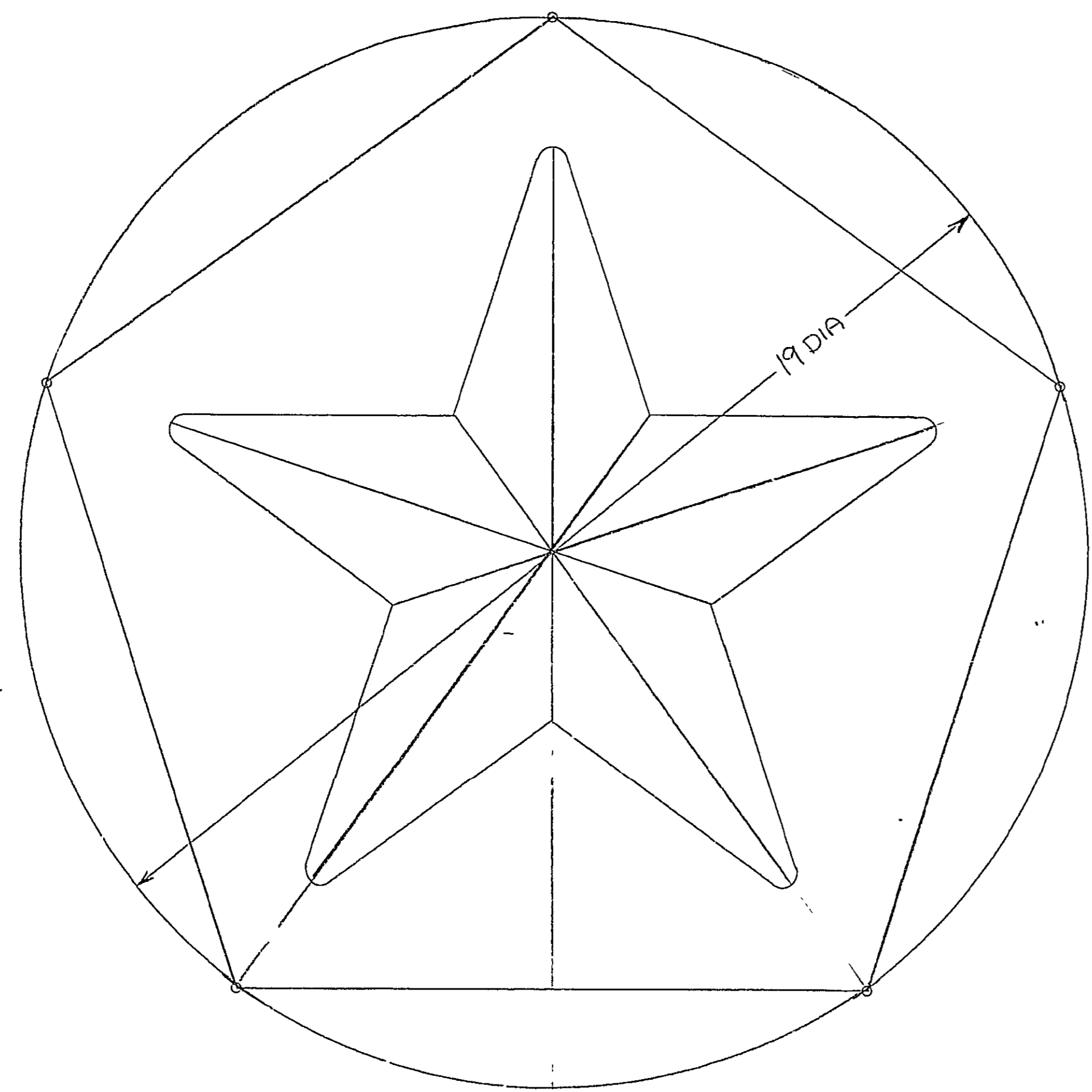

PLAN & ELEVATION OF STAR
SCALE: 6"=1'-0"

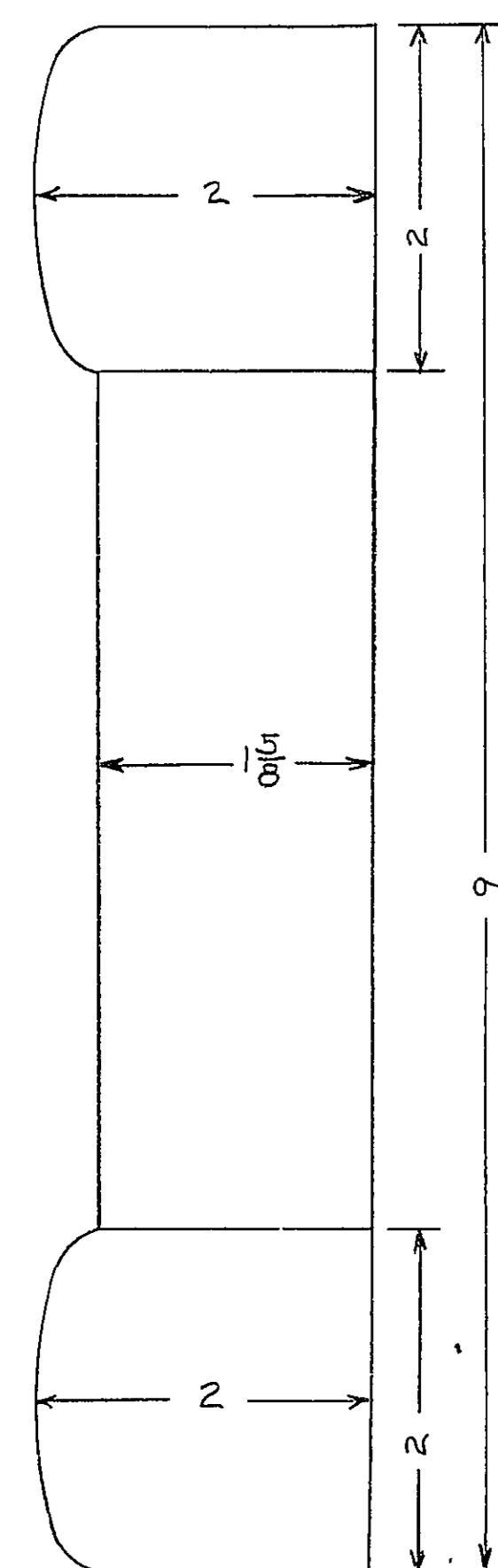
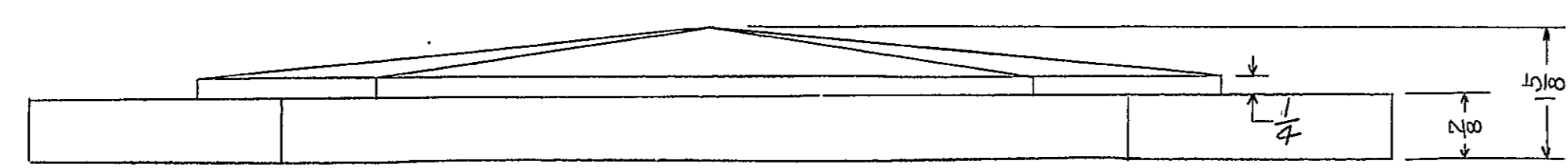

ELEVATION OF NAMEBOARD & LETTERING
SCALE: FULL SIZE

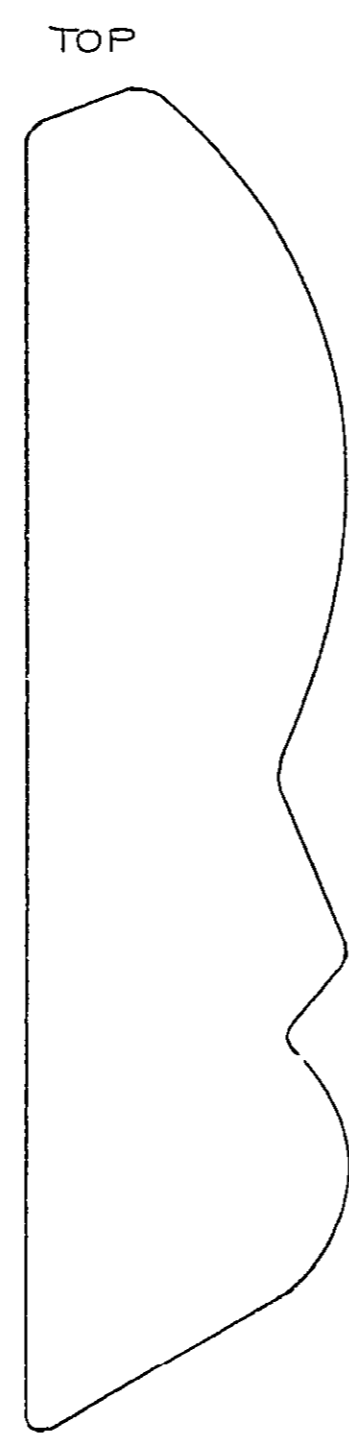

SECTION OF MOLDING BELOW GUN DK
STERN PORTS
SCALE: FULL SIZE

TOP

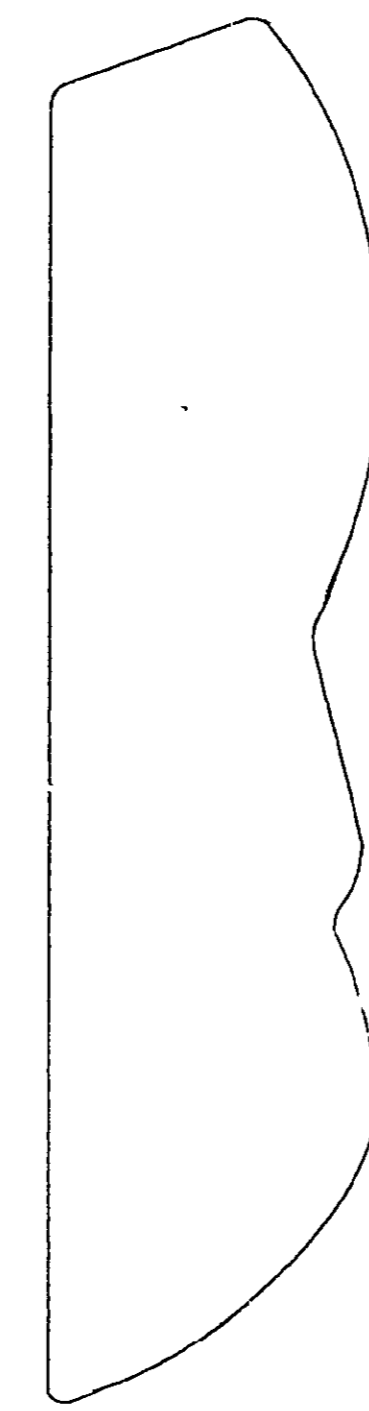

SECTION OF MOLDING AT BOTTOM KNUCKLE
SCALE: FULL SIZE

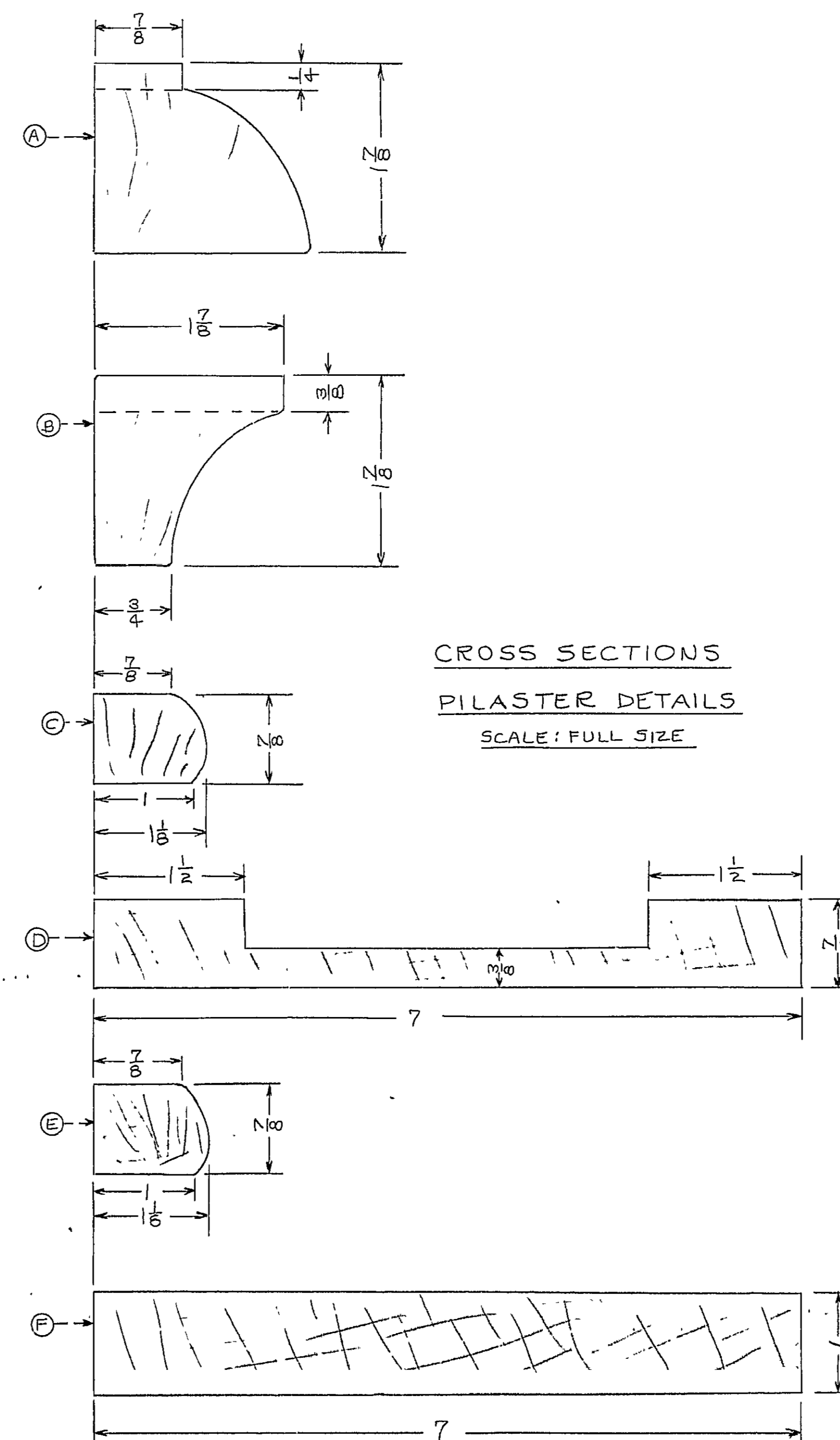

CROSS SECTIONS
PILASTER DETAILS
SCALE: FULL SIZE

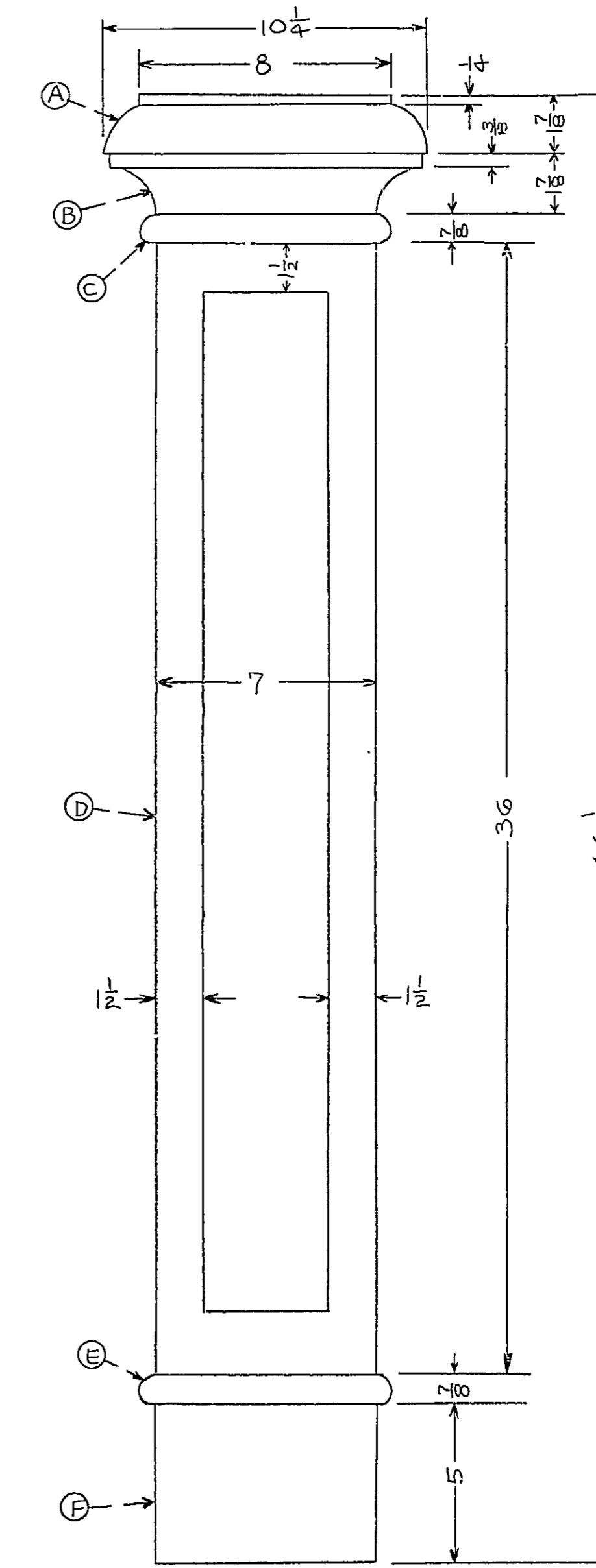

TYPICAL PILASTER
ELEVATION
SCALE: 3"=1'-0"

STERN ORNAMENTATION -	
SECTION OF MOLDINGS	
& DETAILS	
U.S. FRIGATE CONSTITUTION	
SIZE DRAWN: SKRZYPIEC	
H 80060 1X21 BSN	25008
SCALE: AS NOTED	SHEET 1 OF 1